

LME49725

PowerWise® Dual High Performance, High Fidelity Audio Operational Amplifier

General Description

The LME49725 is part of the ultra-low distortion, low noise, high slew rate operational amplifier series optimized and fully specified for high performance, high fidelity applications. Combining advanced leading-edge process technology with state-of-the-art circuit design, the LME49725 audio operational amplifiers deliver superior audio signal amplification for outstanding audio performance. The LME49725 combines extremely low voltage noise density ($3.3\text{nV}/\sqrt{\text{Hz}}$) with vanishingly low THD+N (0.00004%) to easily satisfy the most demanding audio applications. To ensure that the most challenging loads are driven without compromise, the LME49725 has a high slew rate of $\pm 15\text{V}/\mu\text{s}$ and an output current capability of $\pm 22\text{mA}$. Further, dynamic range is maximized by an output stage that drives $2\text{k}\Omega$ loads to within 1V of either power supply voltage and to within 1.4V when driving 600Ω loads.

Part of the PowerWise® family of energy efficient solutions, the LME49725 consumes only 3.0mA of supply current per amplifier while providing superior performance to high performance, high fidelity applications.

The LME49725's outstanding CMRR (120dB), PSRR (120dB), and V_{OS} (0.5mV) give the amplifier excellent operational amplifier DC performance.

The LME49725 has a wide supply range of $\pm 4.5\text{V}$ to $\pm 18\text{V}$. Over this supply range the LME49725's input circuitry maintains excellent common-mode and power supply rejection, as well as maintaining its low input bias current. The LME49725 is unity gain stable. This audio operational amplifier achieves outstanding AC performance while driving complex loads with values as high as 100pF .

The LME49725 is available in 8-lead narrow body SOIC.

Key Specifications

■ Power Supply Voltage Range	$\pm 4.5\text{V}$ to $\pm 18\text{V}$
■ THD+N ($A_V = 1$, $V_{OUT} = 3V_{RMS}$, $f_{IN} = 1\text{kHz}$)	
$R_L = 2\text{k}\Omega$	0.00004% (typ)
$R_L = 600\Omega$	0.00004% (typ)
■ Quiescent current per Amplifier	3.0mA (typ)
■ Input Noise Density	$3.3\text{nV}/\sqrt{\text{Hz}}$ (typ)
■ Slew Rate	$\pm 15\text{V}/\mu\text{s}$ (typ)
■ Gain Bandwidth Product	40MHz (typ)
■ Open Loop Gain ($R_L = 600\Omega$)	135dB (typ)
■ Input Bias Current	15nA (typ)
■ Input Offset Voltage	0.5mV (typ)
■ DC Gain Linearity Error	0.000009% (typ)

Features

- Optimized for superior audio signal fidelity
- Output short circuit protection
- PSRR and CMRR exceed 120dB (typ)

Applications

- Audio amplification
- Preamplifiers
- Multimedia
- Phono preamplifiers
- Professional audio
- Equalization and crossover networks
- Line drivers
- Line receivers
- Active filters

Connection Diagrams

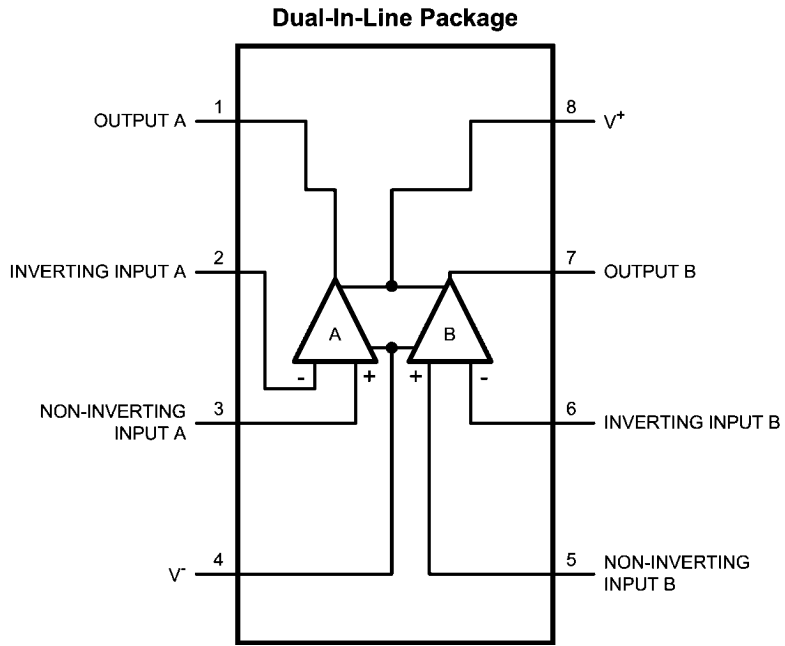

30034255

Order Number LME49725MA
See NS Package Number — M08A

LME49725 Top Mark



300342p0

- N — National logo**
- Z — Assembly plant code**
- X — 1 Digit date code**
- TT — Die traceability**
- L49725 — LME49725**
- MA — Package code**

Absolute Maximum Ratings (Note 1)

If Military/Aerospace specified devices are required, please contact the National Semiconductor Sales Office/Distributors for availability and specifications.

Power Supply Voltage ($V_S = V^+ - V^-$)	38V
Storage Temperature	-65°C to 150°C
Input Voltage	(V ⁻)-0.7V to (V ⁺)+0.7V
Differential Input Voltage	±0.7V
Output Short Circuit (Note 3)	Continuous
Power Dissipation	Internally Limited

ESD Rating (Note 4)	2000V
ESD Rating (Note 5)	
Pins 1, 4, 7 and 8	200V
Pins 2, 3, 5 and 6	100V
Junction Temperature	150°C
Thermal Resistance	
θ_{JA} (SO)	145°C/W
Temperature Range	
$T_{MIN} \leq T_A \leq T_{MAX}$	-40°C ≤ T _A ≤ 85°C
Supply Voltage Range	±4.5V ≤ V _S ≤ ±18V

Electrical Characteristics for the LME49725 (Note 2) The specifications apply for V_S = ±15V, R_L = 2kΩ, f_{IN} = 1kHz, T_A = 25°C, unless otherwise specified.

Symbol	Parameter	Conditions	LME49725		Units (Limits)
			Typical	Limit	
			(Note 6)	(Note 7)	
THD+N	Total Harmonic Distortion + Noise	A _V = 1, V _{OUT} = 3V _{rms}			
		R _L = 2kΩ	0.00004		%
		R _L = 600Ω	0.00004	0.0002	%
IMD	Intermodulation Distortion	A _V = 1, V _{OUT} = 3V _{RMS} Two-tone, 60Hz & 7kHz 4:1	0.00005		%
GBWP	Gain Bandwidth Product		40	30	MHz (min)
SR	Slew Rate		±15	±10	V/μs (min)
FPBW	Full Power Bandwidth	V _{OUT} = 1V _{P-P} , -3dB referenced to output magnitude at f = 1kHz	7		MHz
t _s	Settling time	A _V = -1, 10V step, C _L = 100pF 0.1% error range	1.6		μs
e _n	Equivalent Input Noise Voltage	f _{BW} = 20Hz to 20kHz	0.4	0.8	μV _{RMS} (max)
	Equivalent Input Noise Density	f = 1kHz f = 10Hz	3.3 20	5.2	nV/√Hz (max)
i _n	Current Noise Density	f = 1kHz	1.4		pA/√Hz
		f = 10Hz	3.5		pA/√Hz
V _{OS}	Offset Voltage		±0.5	±1.0	mV (max)
ΔV _{OS} /ΔTemp	Average Input Offset Voltage Drift vs Temperature	-40°C ≤ T _A ≤ 85°C	0.2		μV/°C
PSRR	Average Input Offset Voltage Shift vs Power Supply Voltage	ΔV _S = 20V (Note 8)	120	100	dB (min)
ISO _{CH-CH}	Channel-to-Channel Isolation	f _{IN} = 1kHz	118		dB
		f _{IN} = 20kHz	112		dB
I _B	Input Bias Current	V _{CM} = 0V	±15	±90	nA (max)
ΔI _{OS} /ΔTemp	Input Bias Current Drift vs Temperature	-40°C ≤ T _A ≤ 85°C	0.1		nA/°C
I _{OS}	Input Offset Current	V _{CM} = 0V	11	65	nA (max)
V _{IN-CM}	Common-Mode Input Voltage Range		±13.9	(V ⁺)-2.0 (V ⁻)+2.0	V (min) V (min)
CMRR	Common-Mode Rejection	-10V < V _{cm} < 10V	120	100	dB (min)
Z _{IN}	Differential Input Impedance		30		kΩ
	Common Mode Input Impedance	-10V < V _{cm} < 10V	1000		MΩ

Symbol	Parameter	Conditions	LME49725		Units (Limits)
			Typical	Limit	
			(Note 6)	(Note 7)	
A _{VOL}	Open Loop Voltage Gain	-10V < V _{out} < 10V, R _L = 600Ω	135	110	dB (min)
		-10V < V _{out} < 10V, R _L = 2kΩ	135		dB
		-10V < V _{out} < 10V, R _L = 10kΩ	135		dB
V _{OUTMAX}	Maximum Output Voltage Swing	R _L = 600Ω	±13.6	±11.5	V (min)
		R _L = 2kΩ	±13.9		V
		R _L = 10kΩ	±14.0		V
I _{OUT}	Output Current	R _L = 600Ω, V _S = ±17V	±22		mA (min)
I _{OUT-CC}	Instantaneous Short Circuit Current		+45 -35		mA mA
R _{OUT}	Output Impedance	f _{IN} = 10kHz Closed-Loop	0.01		Ω
		Open-Loop	18		Ω
C _{LOAD}	Capacitive Load Drive Overshoot	100pF	16		%
I _S	Quiescent Current per Amplifier	I _{OUT} = 0mA	3.0	4.5	mA (max)
f _C	1/f Corner Frequency		120		Hz

Note 1: "Absolute Maximum Ratings" indicate limits beyond which damage to the device may occur, including inoperability and degradation of device reliability and/or performance. Functional operation of the device and/or non-degradation at the *Absolute Maximum Ratings* or other conditions beyond those indicated in the *Recommended Operating Conditions* is not implied. The *Recommended Operating Conditions* indicate conditions at which the device is functional and the device should not be operated beyond such conditions. All voltages are measured with respect to the ground pin, unless otherwise specified.

Note 2: The *Electrical Characteristics* tables list guaranteed specifications under the listed *Recommended Operating Conditions* except as otherwise modified or specified by the *Electrical Characteristics Conditions* and/or Notes. Typical specifications are estimations only and are not guaranteed.

Note 3: The maximum power dissipation must be derated at elevated temperatures and is dictated by T_{JMAX}, θ_{JA}, and the ambient temperature, T_A. The maximum allowable power dissipation is P_{DMAX} = (T_{JMAX} - T_A) / θ_{JA} or the number given in *Absolute Maximum Ratings*, whichever is lower.

Note 4: Human body model, applicable std. JESD22-A114C.

Note 5: Machine model, applicable std. JESD22-A115-A.

Note 6: Typical values represent most likely parametric norms at T_A = +25°C, and at the *Recommended Operation Conditions* at the time of product characterization and are not guaranteed.

Note 7: Datasheet min/max specification limits are guaranteed by test or statistical analysis.

Note 8: PSRR is measured as follows: V_{OS} is measured at two supply voltages, ±5V and ±15V, PSRR = |20log(ΔV_{OS}/ΔV_S)|.

Typical Performance Characteristics

THD+N vs Frequency
 $V_S = 4.5V, V_{OUT} = 1.2V_{RMS}, R_L = 600\Omega$

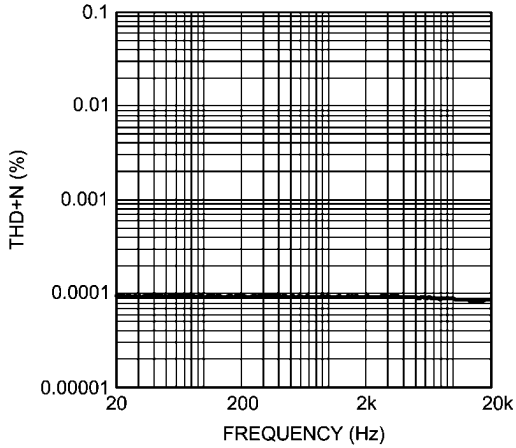

300342a6

THD+N vs Frequency
 $V_S = 15V, V_{OUT} = 3V_{RMS}, R_L = 600\Omega$

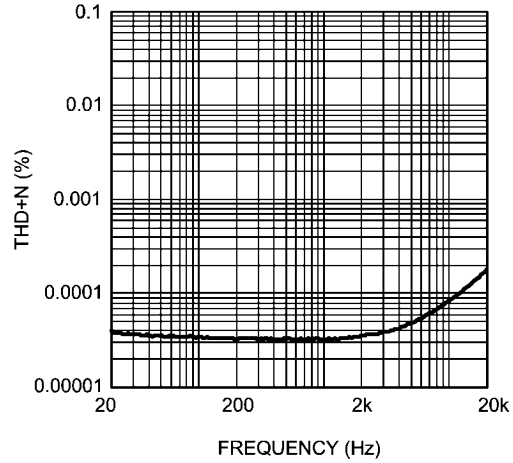

300342b1

THD+N vs Frequency
 $V_S = 18V, V_{OUT} = 3V_{RMS}, R_L = 600\Omega$

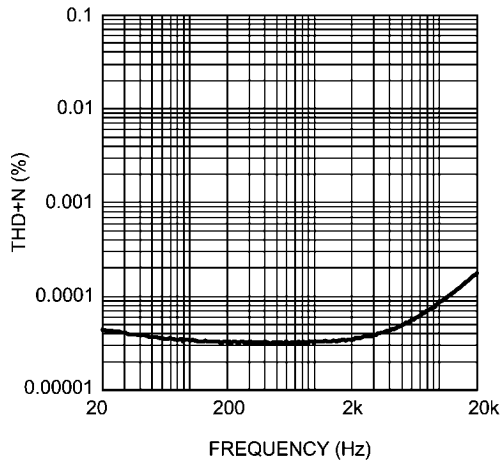

300342b4

THD+N vs Frequency
 $V_S = 4.5V, V_{OUT} = 1.2V_{RMS}, R_L = 2k\Omega$

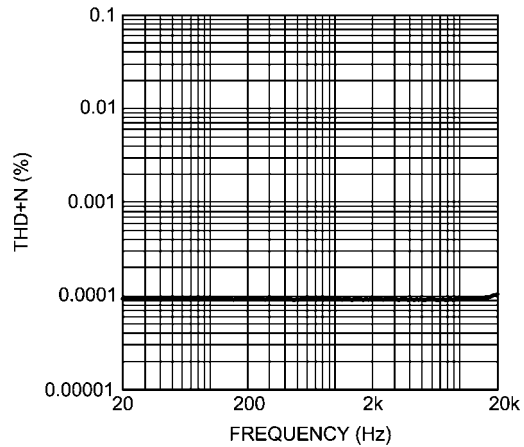

300342a4

THD+N vs Frequency
 $V_S = 15V, V_{OUT} = 3V_{RMS}, R_L = 2k\Omega$

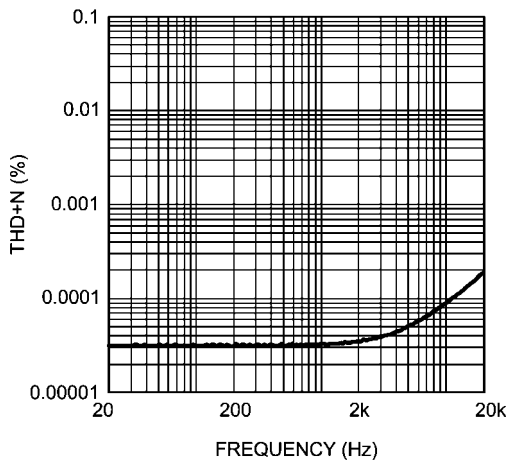

300342a9

THD+N vs Frequency
 $V_S = 18V, V_{OUT} = 3V_{RMS}, R_L = 2k\Omega$

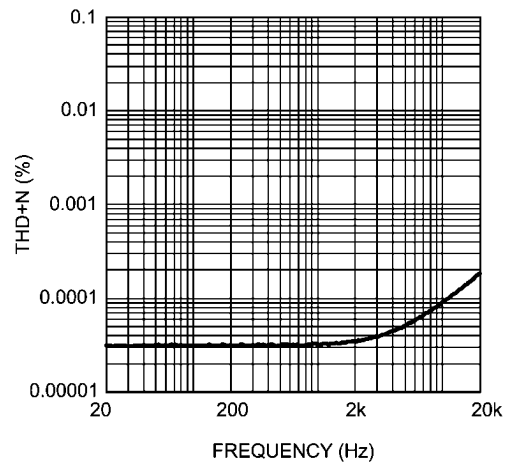

300342b2

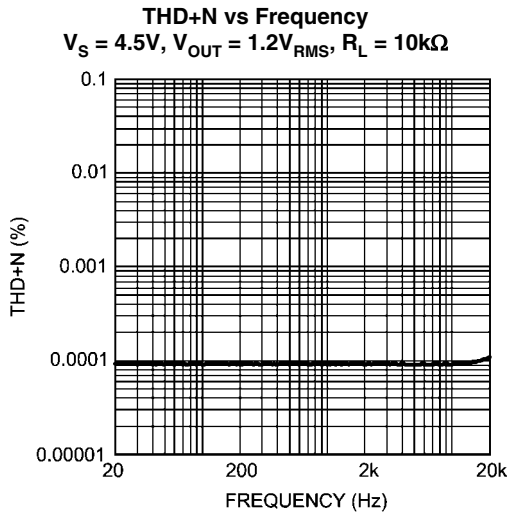

300342a5

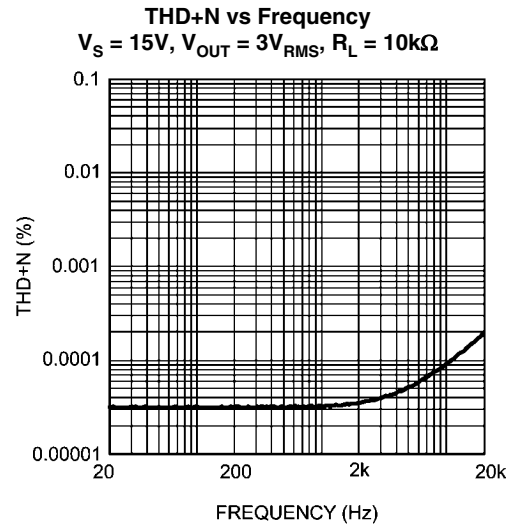

300342b0

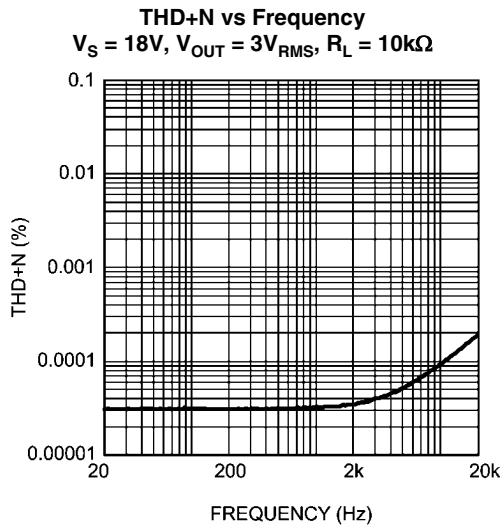

300342b3

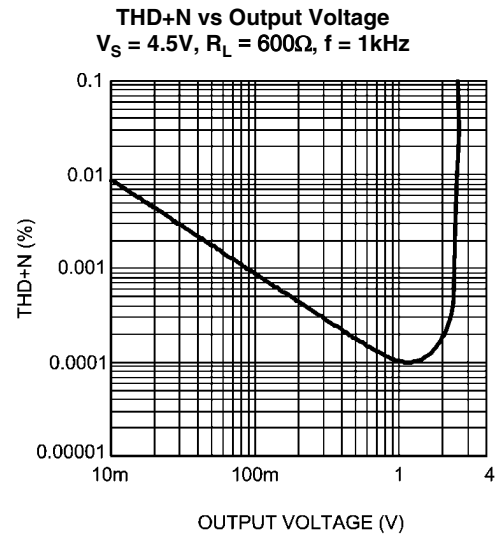

30034234

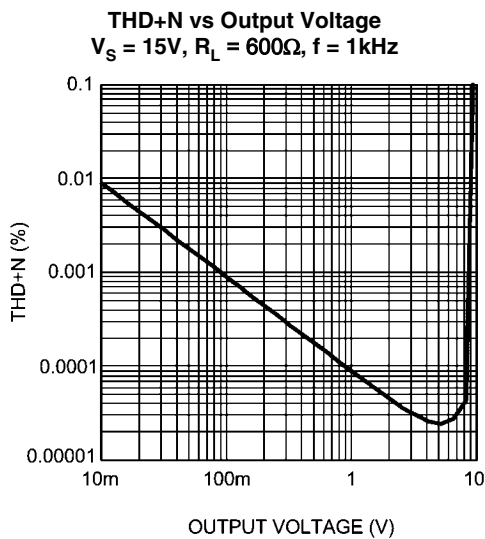

30034235

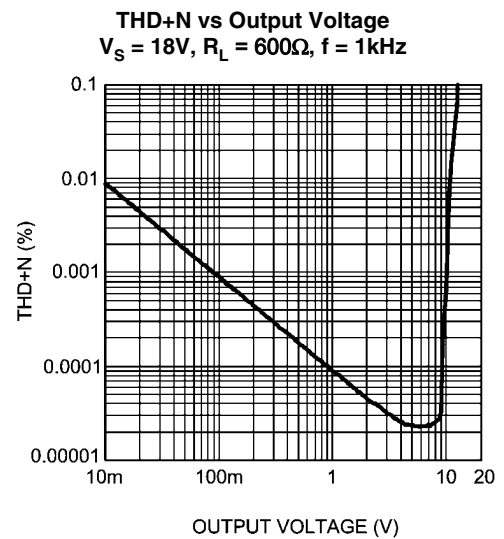

30034236

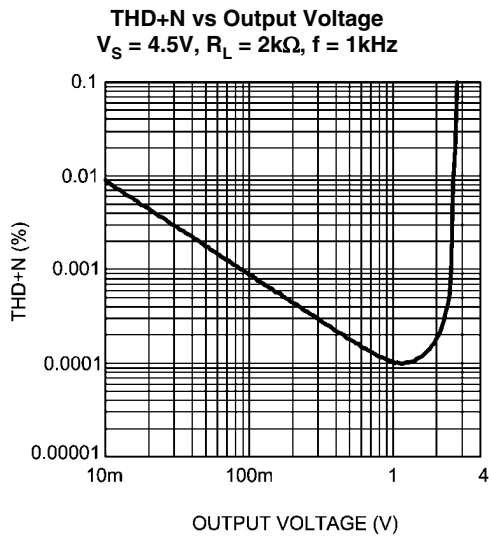

30034228

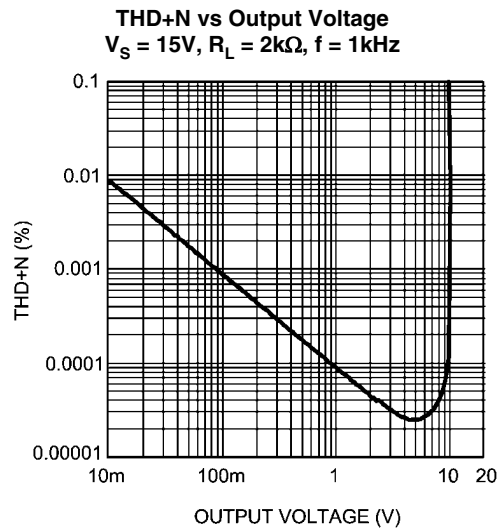

30034229

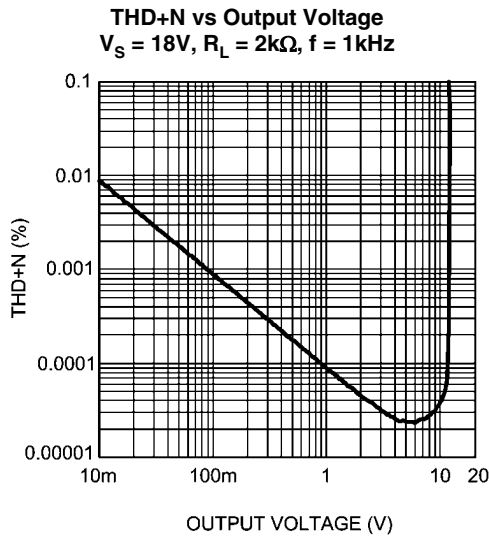

30034230

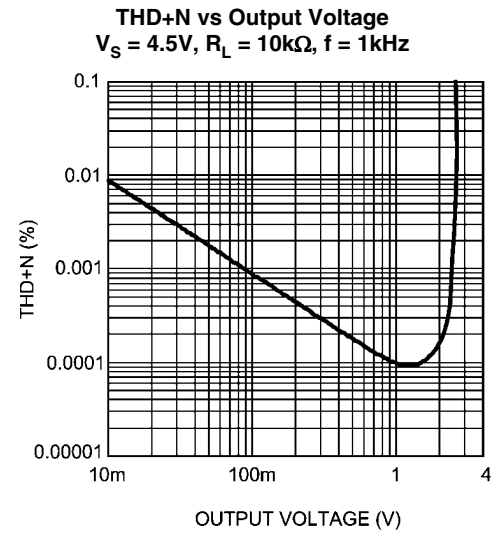

30034231

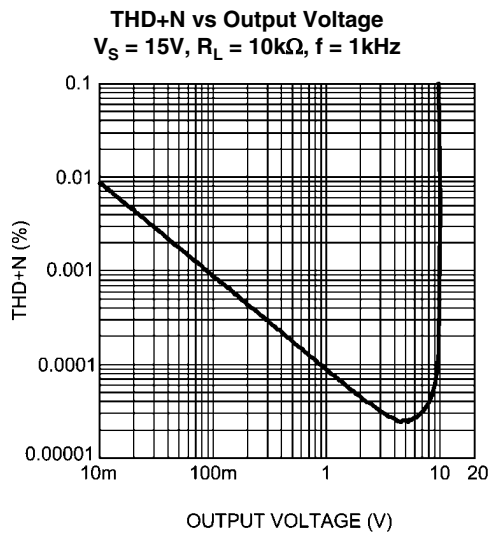

30034232

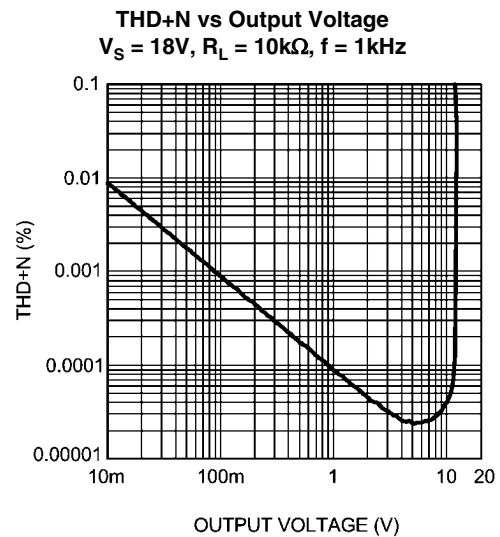

30034233

CMRR vs Frequency
 $V_S = 4.5V, R_L = 600\Omega$

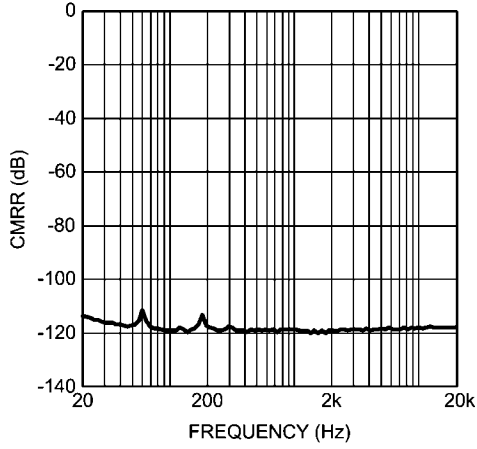

30034283

CMRR vs Frequency
 $V_S = 15V, R_L = 600\Omega$

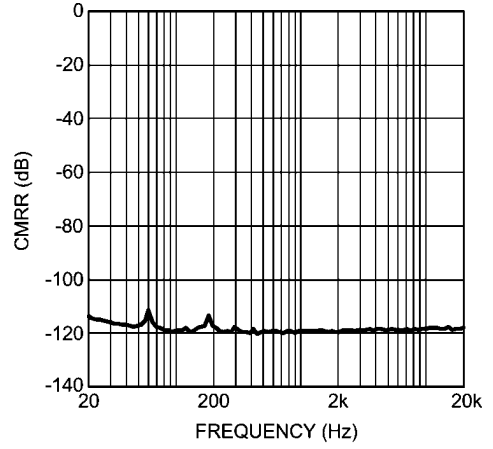

30034284

CMRR vs Frequency
 $V_S = 15V, R_L = 600\Omega$

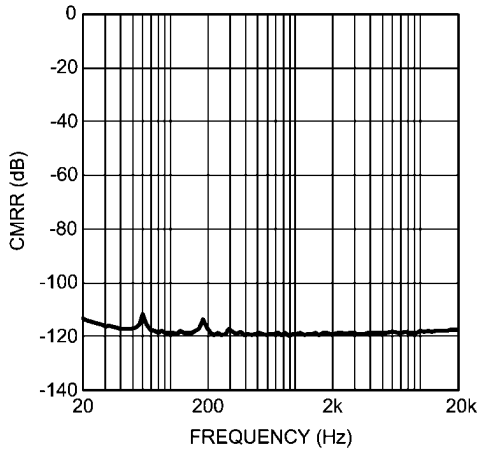

30034285

CMRR vs Frequency
 $V_S = 4.5V, R_L = 2k\Omega$

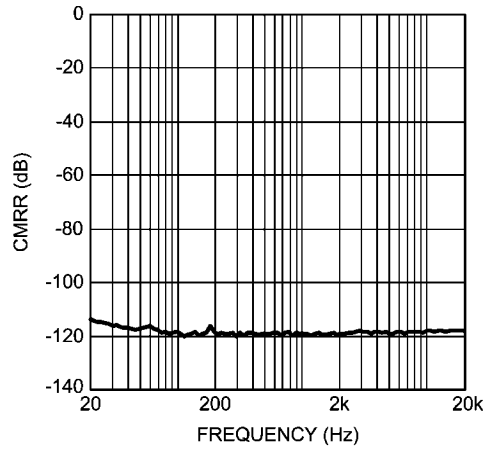

30034277

CMRR vs Frequency
 $V_S = 15V, R_L = 2k\Omega$

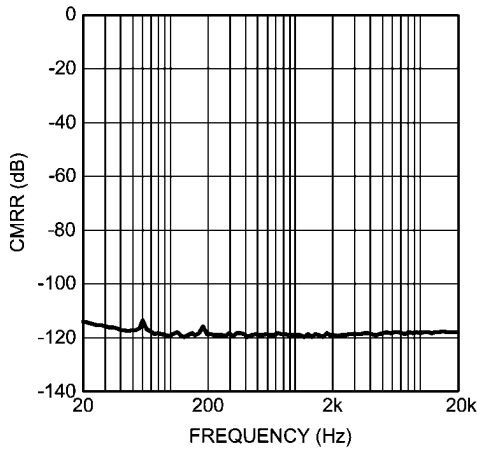

30034278

CMRR vs Frequency
 $V_S = 18V, R_L = 2k\Omega$

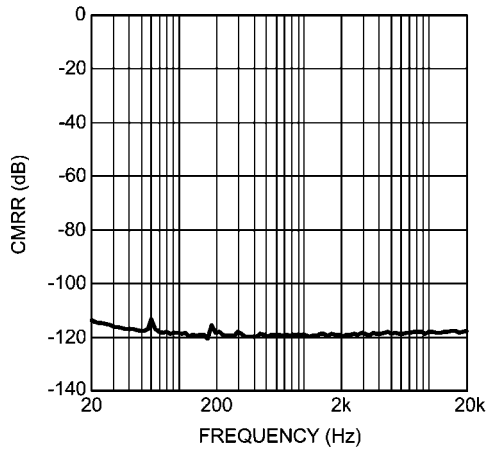

30034279

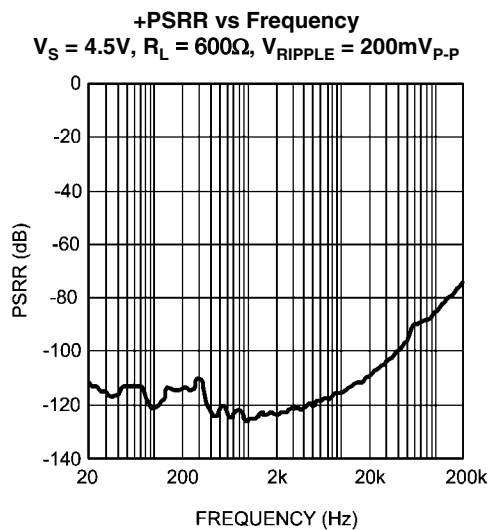
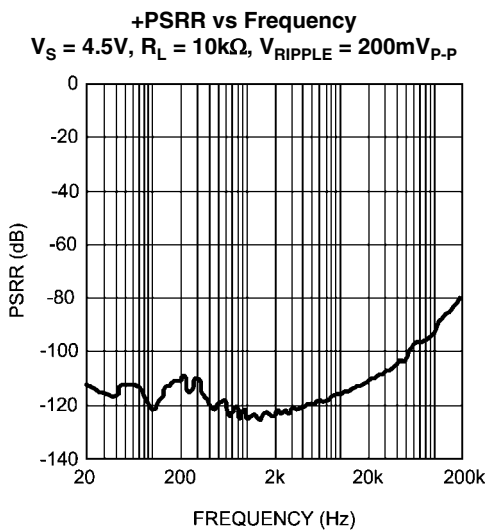
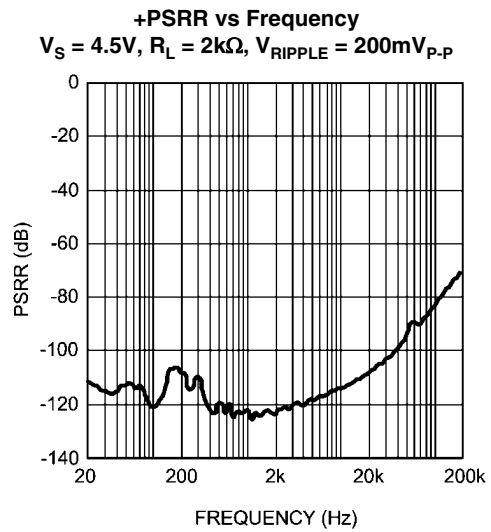
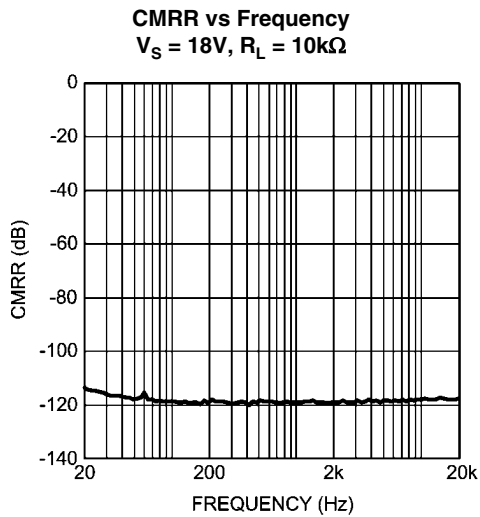
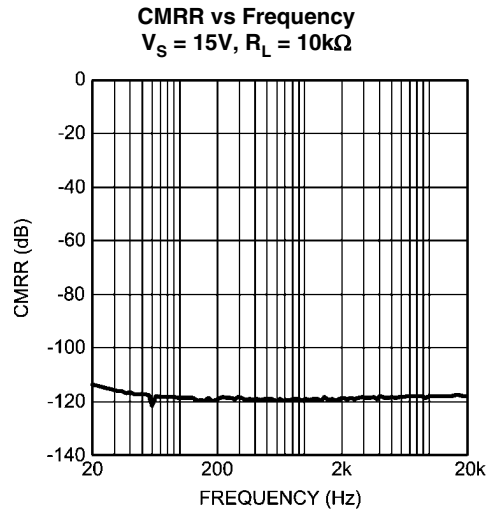
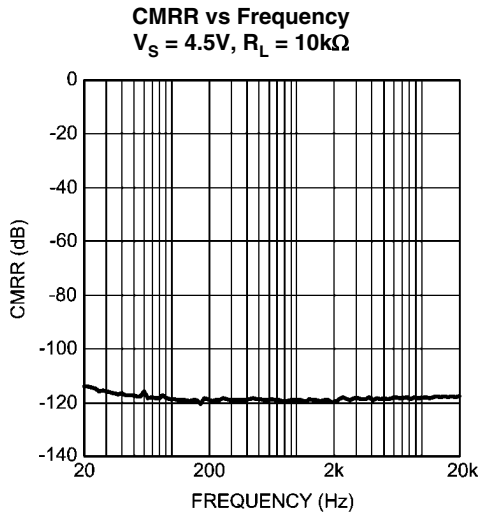

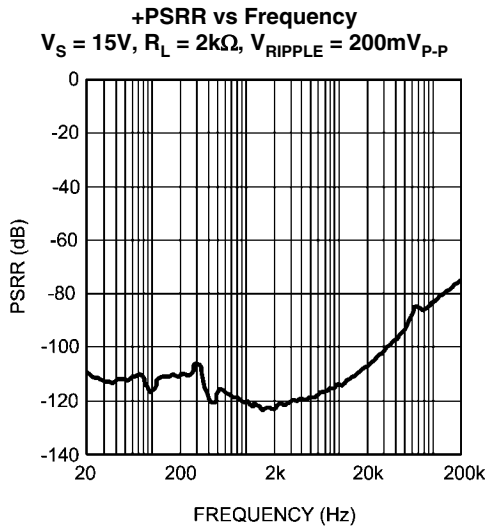

30034271

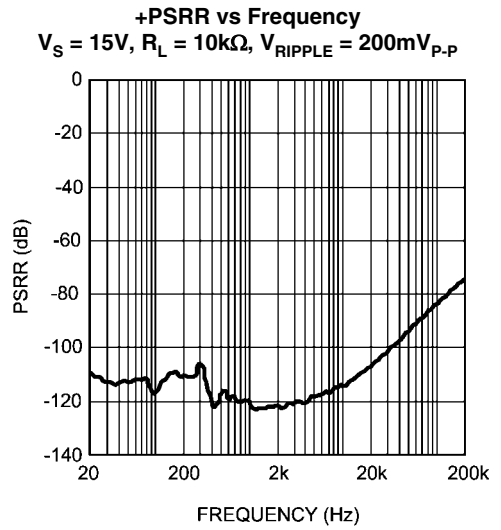

30034272

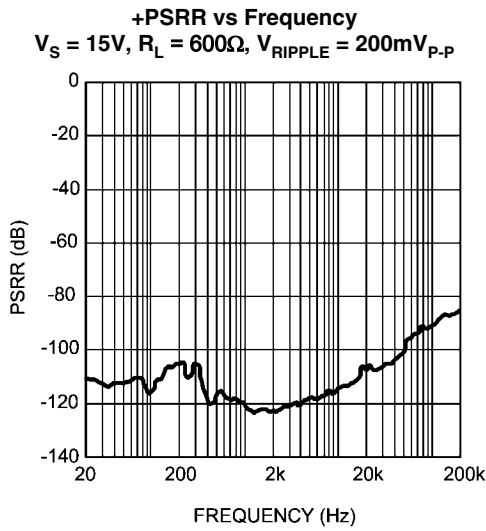

30034273

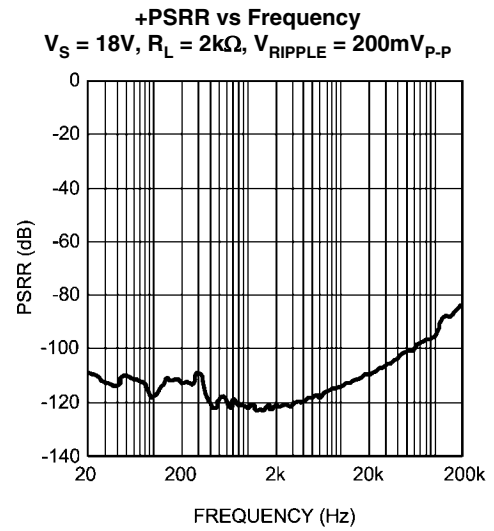

300342a7

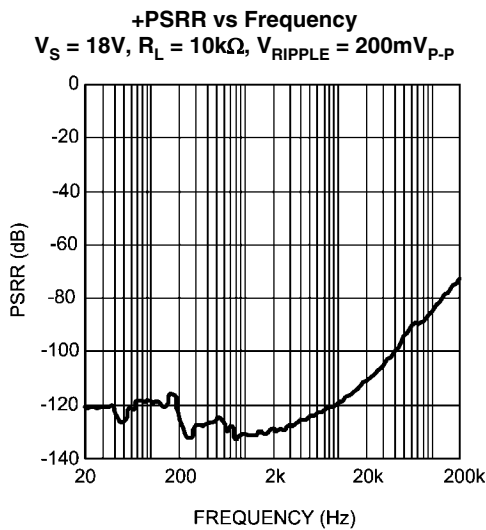

30034275

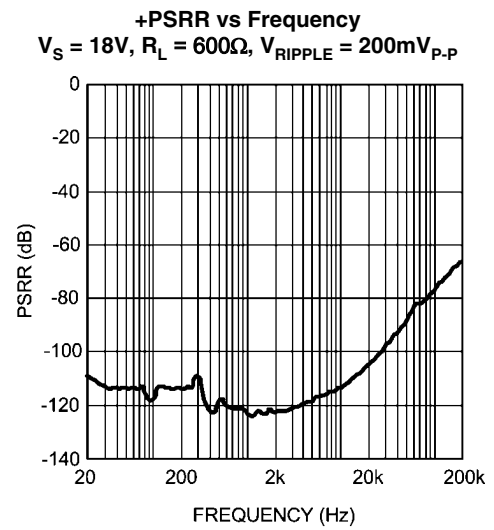

30034276

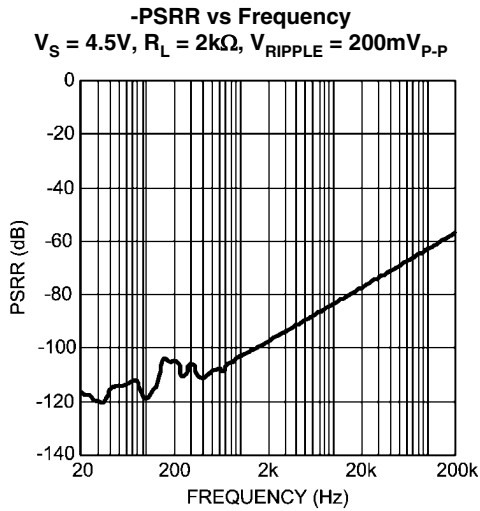

30034295

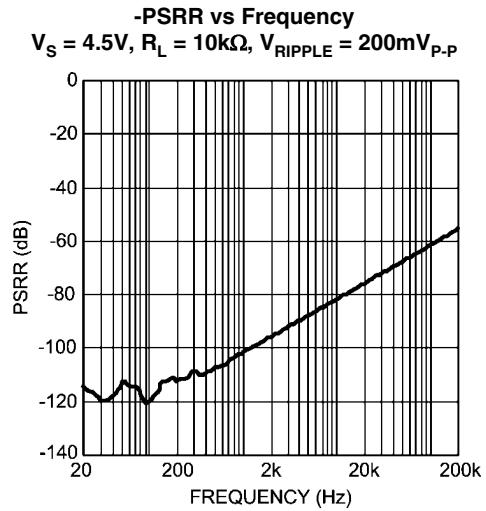

30034296

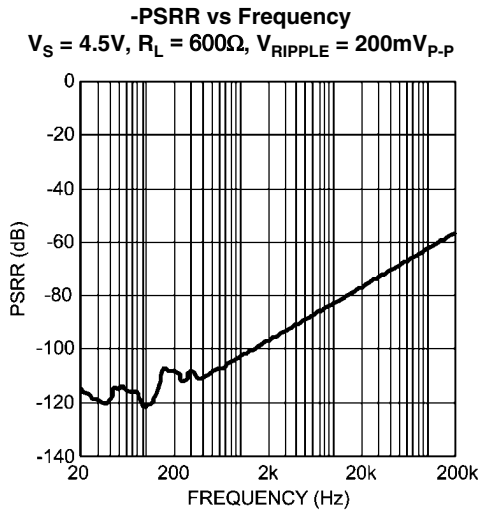

30034297

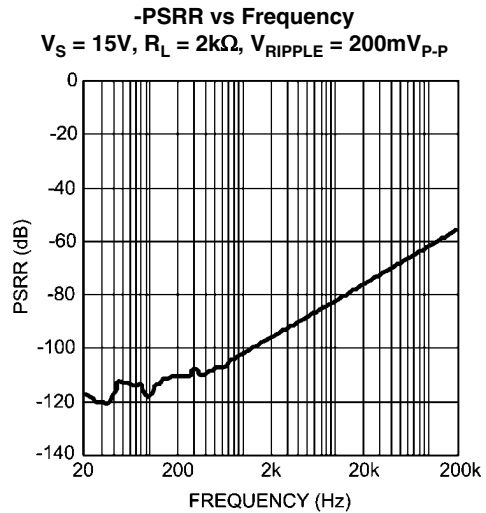

30034298

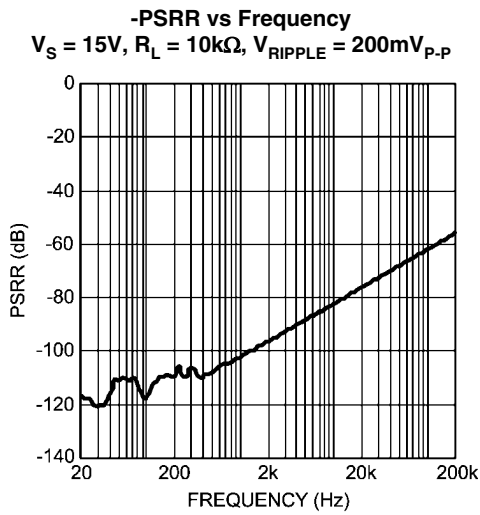

30034299

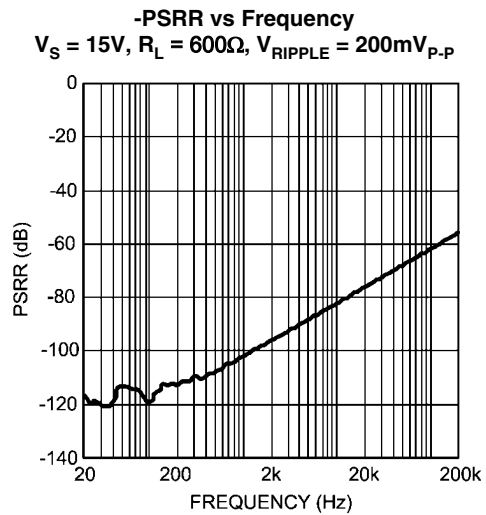

300342a0

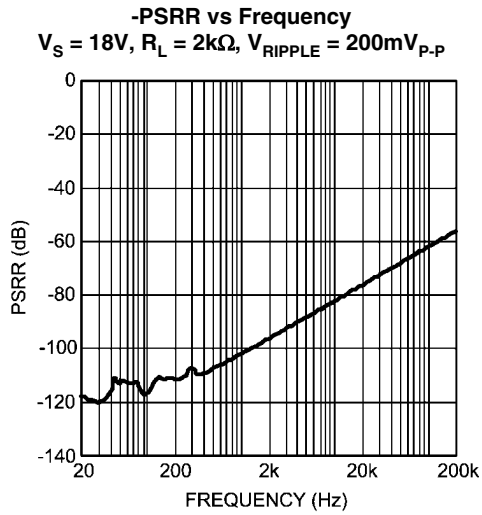

300342a1

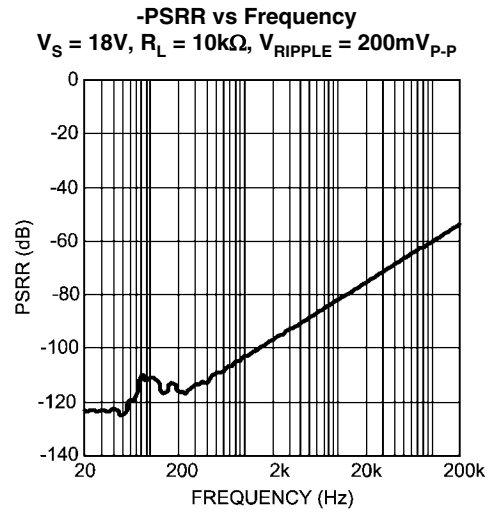

300342a2

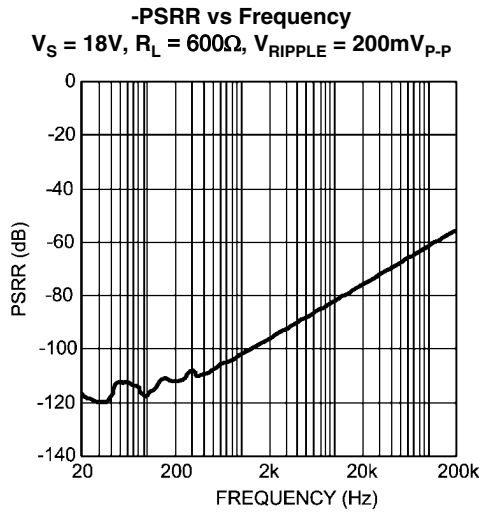

300342a3

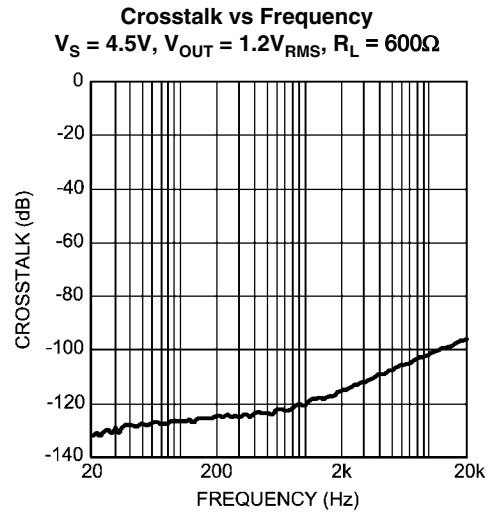

30034292

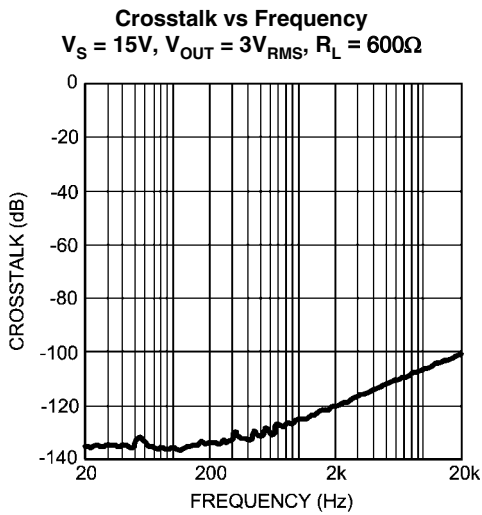

30034293

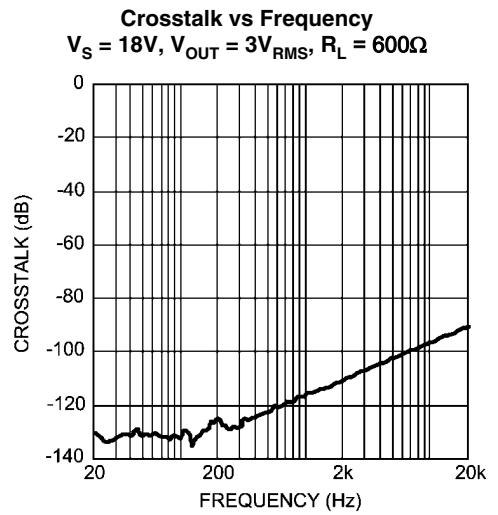

30034294

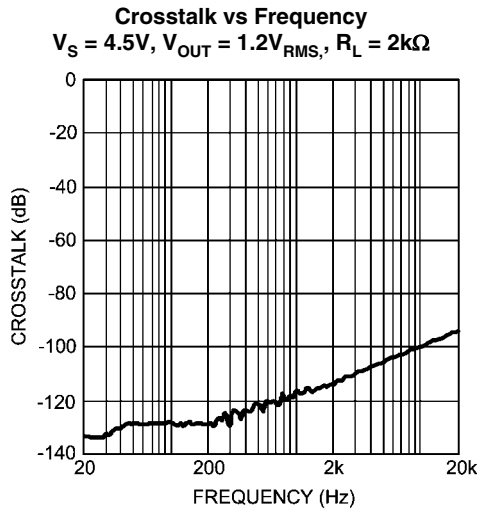

30034286

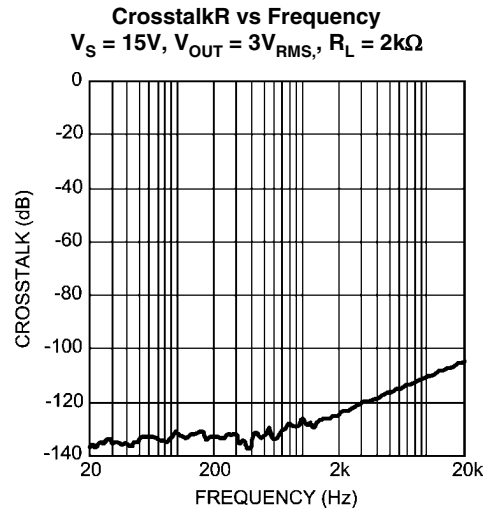

30034287

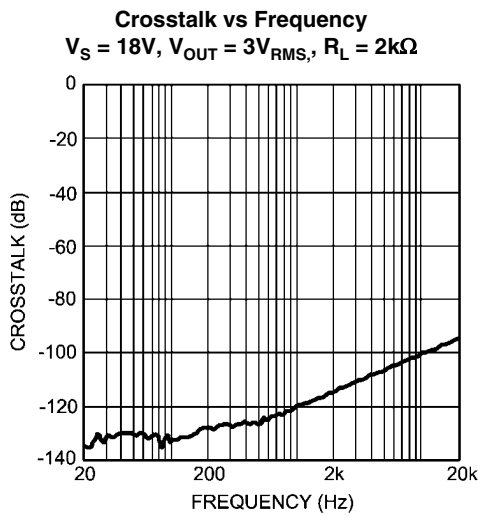

30034288

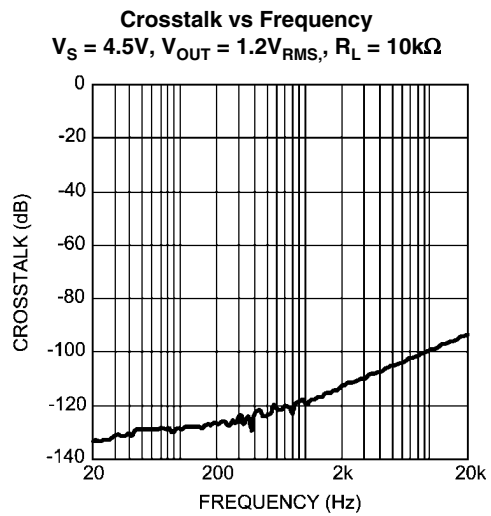

30034289

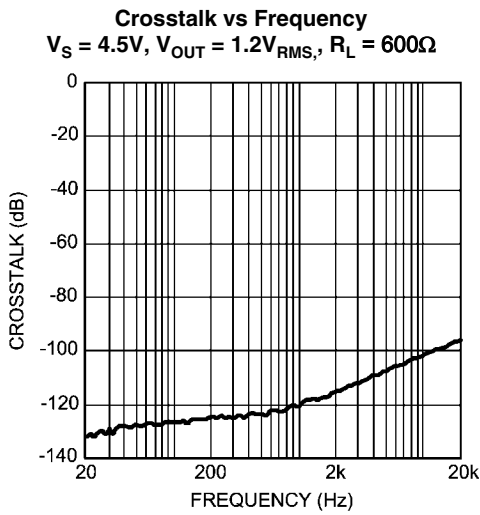

30034292

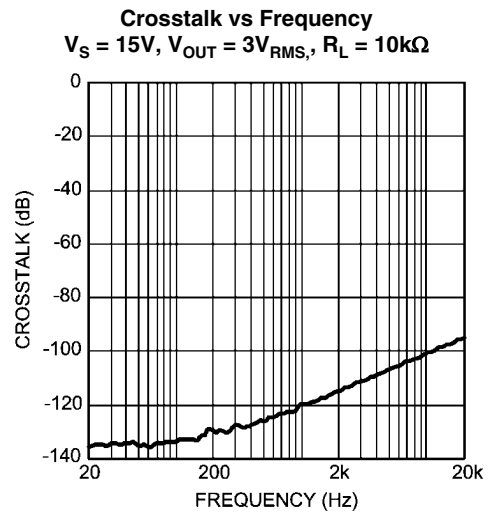

30034290

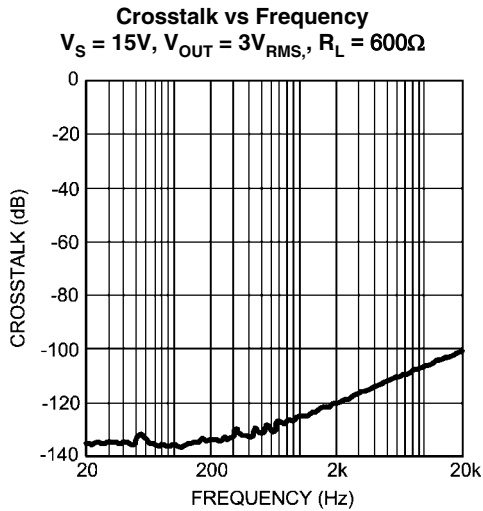

30034293

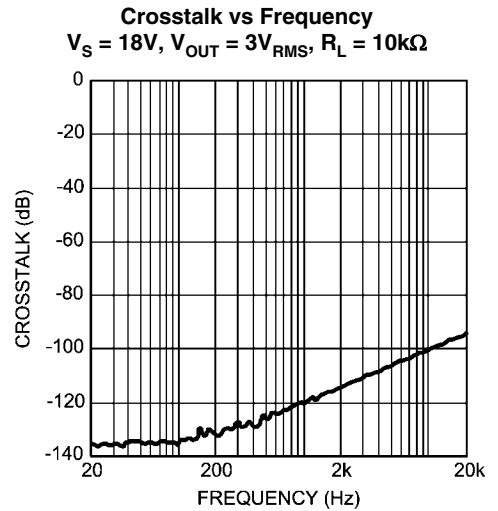

30034291

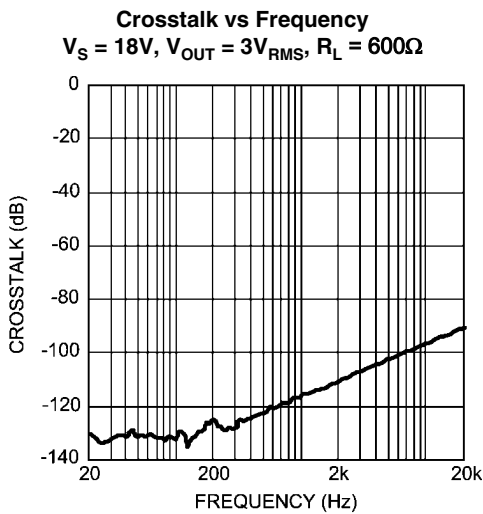

30034294

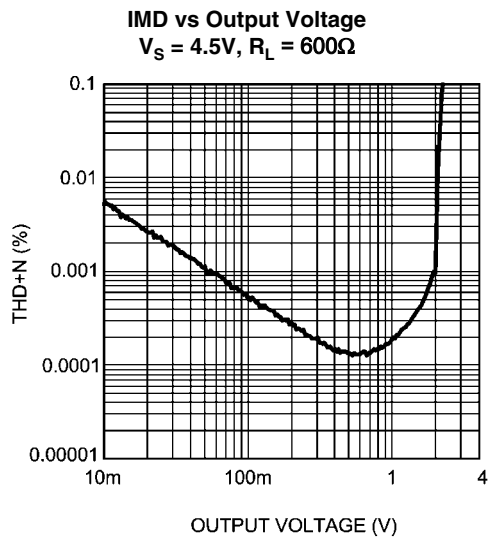

30034216

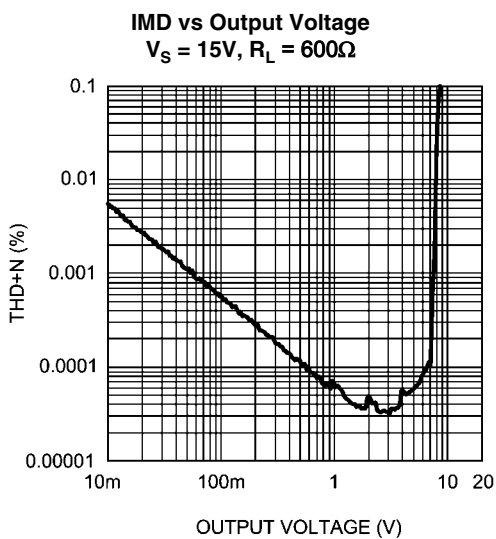

30034266

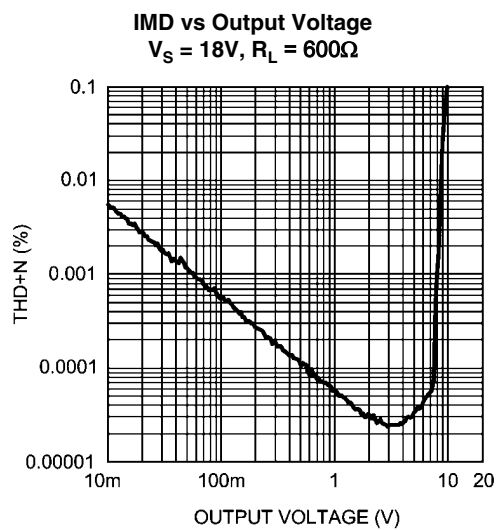

30034267

IMD vs Output Voltage
 $V_S = 4.5V, R_L = 2k\Omega$

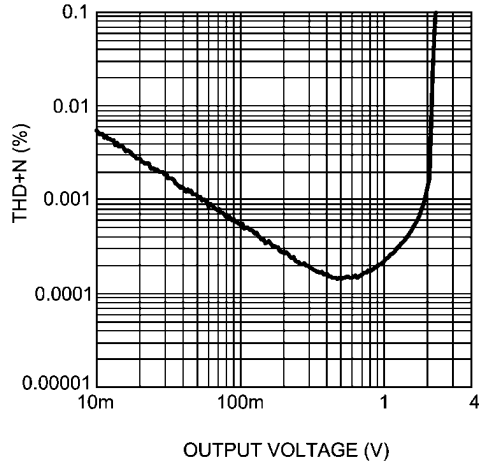

30034210

IMD vs Output Voltage
 $V_S = 15V, R_L = 2k\Omega$

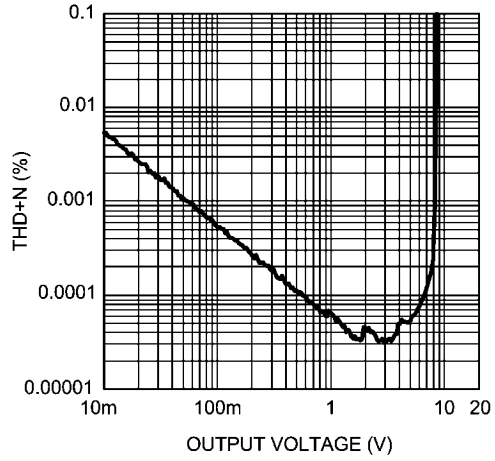

30034264

IMD vs Output Voltage
 $V_S = 18V, R_L = 2k\Omega$

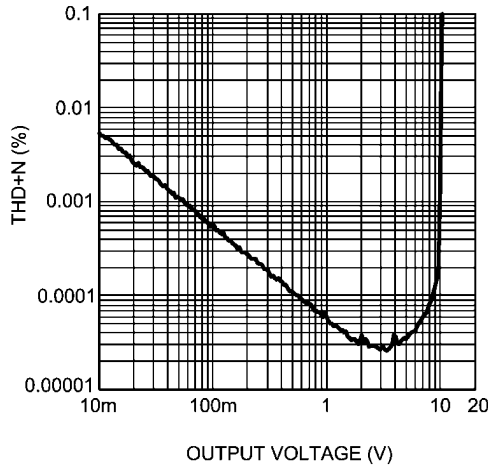

30034212

IMD vs Output Voltage
 $V_S = 4.5V, R_L = 10k\Omega$

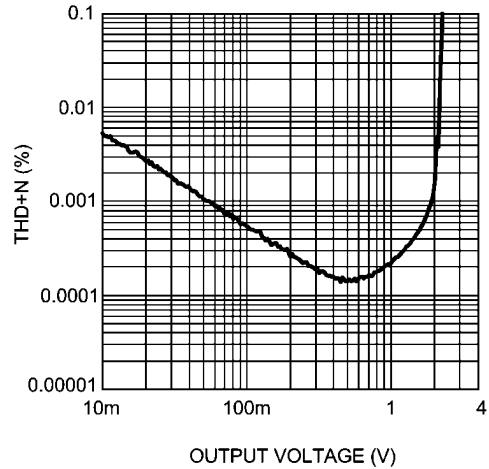

30034213

IMD vs Output Voltage
 $V_S = 15V, R_L = 10k\Omega$

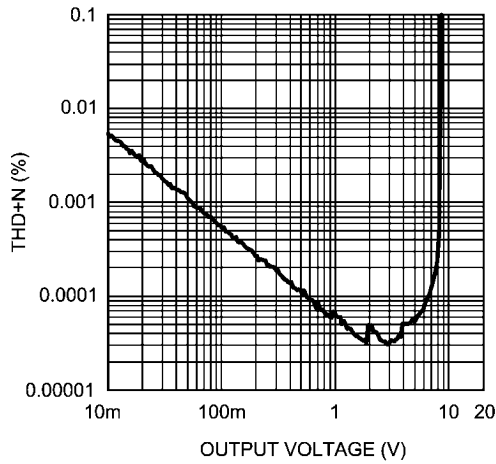

30034265

IMD vs Output Voltage
 $V_S = 18V, R_L = 10k\Omega$

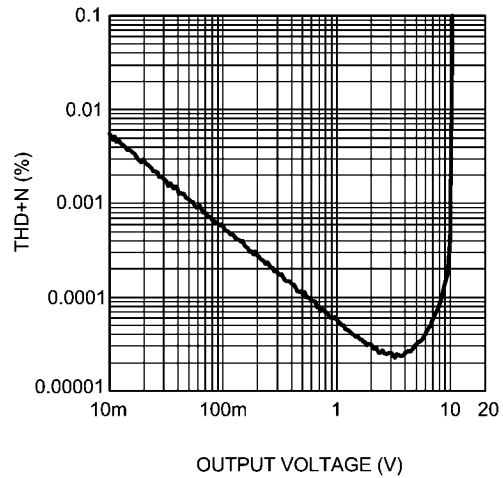

30034215

Total Quiescent Current vs Power Supply

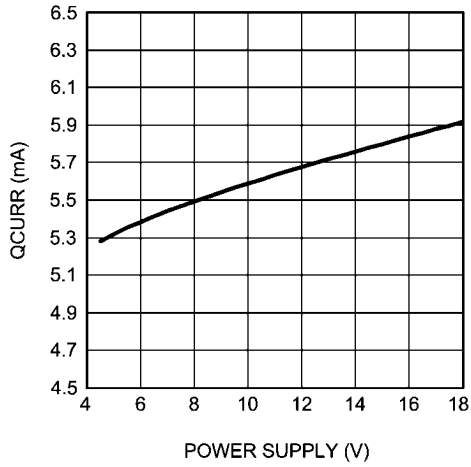

30034246

Voltage Noise Density vs Frequency
 $V_{CC} = 15V, V_{EE} = -15V, \text{No Load}$

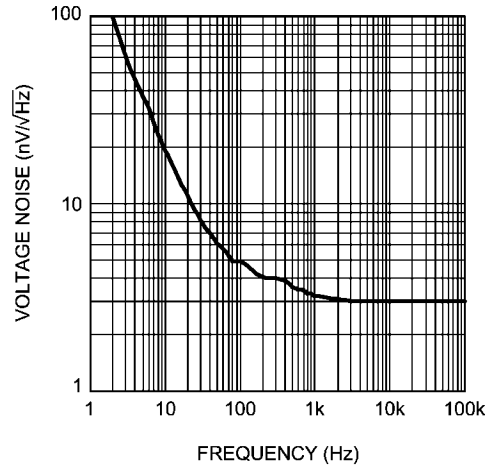

30034247

Current Noise vs Frequency
 $V_{CC} = 15V, V_{EE} = -15V, \text{No Load}$

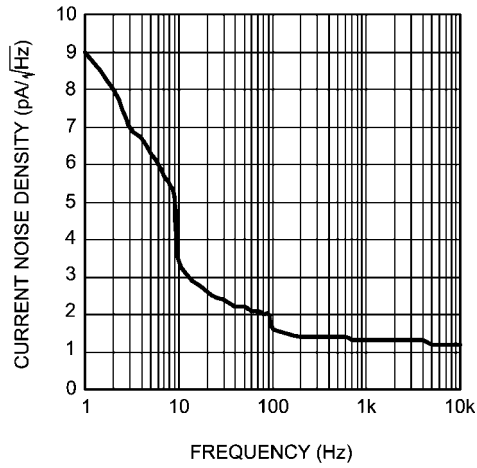

300342a8

Application Information

OPERATING RATINGS AND BASIC DESIGN GUIDELINES

The LME49725 has a supply voltage range from +9V to +36V single supply or $\pm 4.5V$ to $\pm 18V$ dual supply.

Bypass capacitors for the supplies should be placed as close to the amplifier as possible. This will help minimize any in-

ductance between the power supply and the supply pins. In addition to a 10 μ F capacitor, a 0.1 μ F capacitor is also recommended.

The amplifier's inputs lead lengths should also be as short as possible. If the op amp does not have a bypass capacitor, it may oscillate.

Demonstration Board Schematic

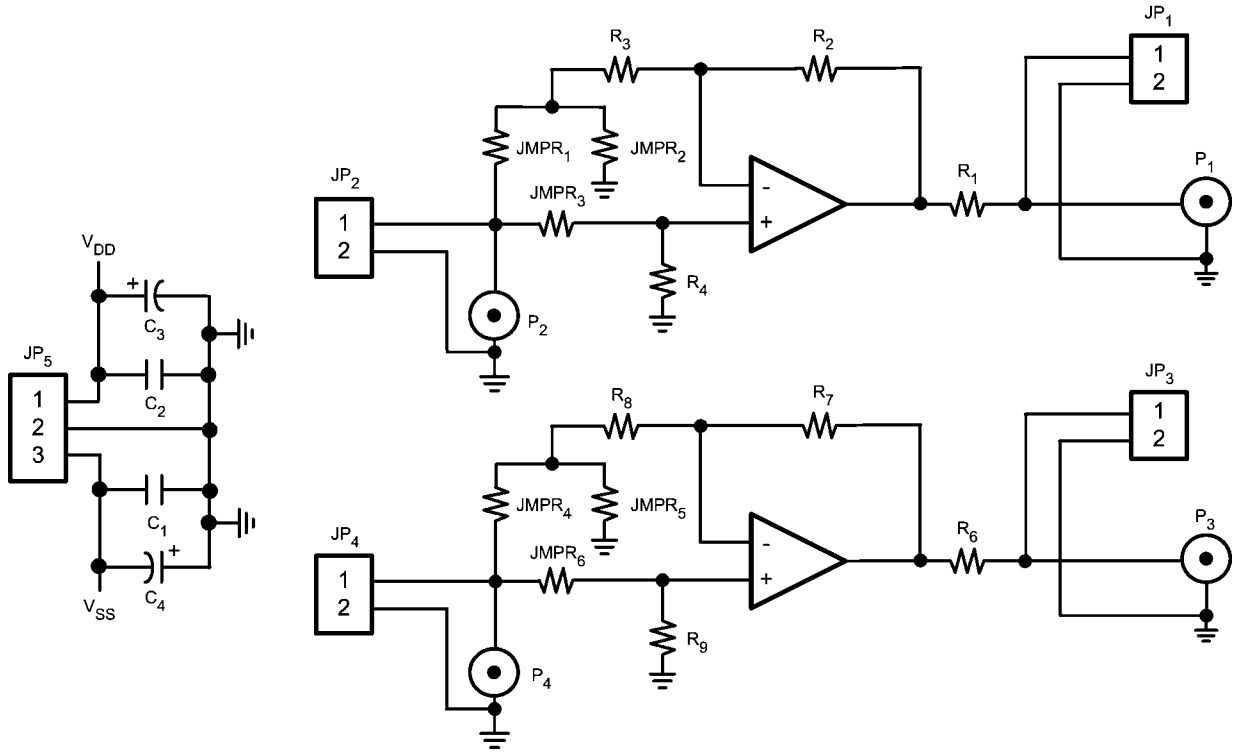

30034260

Bill Of Materials For Demonstration Board (Inverting Configuration)

Description	Designator	Part Number	Mfg
Ceramic Capacitor 0.1 μ F, 10% 50V 0805 SMD	C1, C2	C0805C104K3RAC7533	Kemet
Tantalum Capacitor 10 μ F, 10% 20V, B-size	C3, C4	T491B106K025AT	Kemet
Resistor 0 Ω , 1/8W, 1% 0805 SMD	JMPR1, JMPR4, R1, R4, R6, R9	CRCW0805000020EA	Vishay
Resistor 10k Ω , 1/8W, 1% 0805 SMD	R2, R3, R8, R7	CRCW080510K0FKEA	Vishay
Header, 2-Pin	JP1, JP2, JP3, JP4		
Header, 3-Pin	JP5		
SMA stand-up connectors	P1-P4 (Optional)	132134	Amphenol COnnex

Note: Do not stuff Jmpr2, Jmpr3, Jmpr5, and Jmpr6.

Demonstration Board Layout

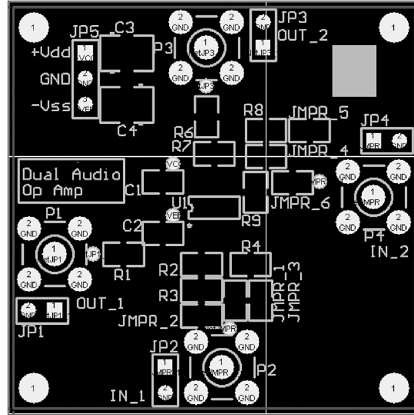

Silkscreen Layer

30034262

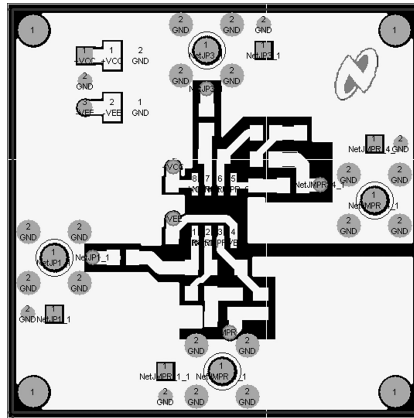

Top Layer

30034263

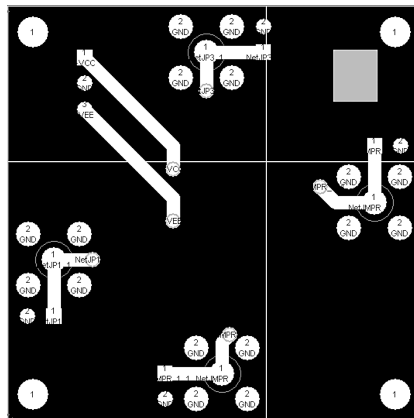

Bottom Layer

30034261

Revision History

Rev	Date	Description
1.0	04/03/08	Initial release.

Physical Dimensions inches (millimeters) unless otherwise noted

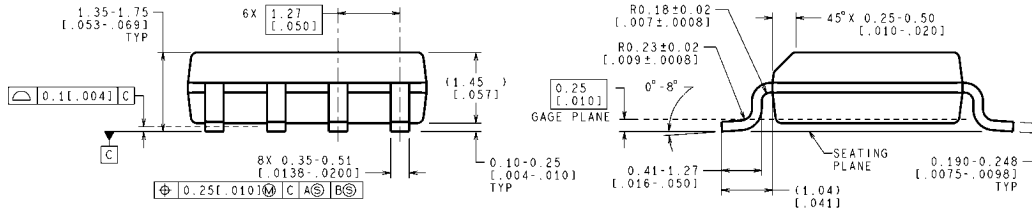
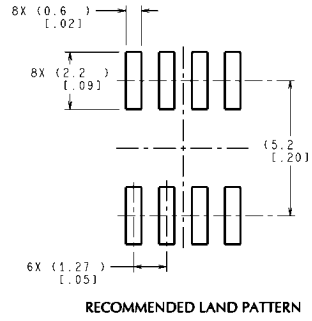
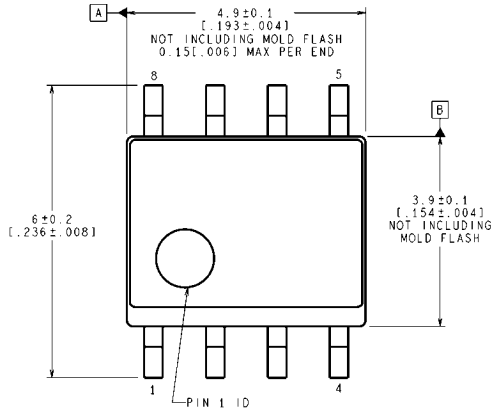

CONTROLLING DIMENSION IS MILLIMETER
 VALUES IN [] ARE INCHES
 DIMENSIONS IN () FOR REFERENCE ONLY

M08A (Rev L)

Narrow SOIC Package
Order Number LME49725MA
NS Package Number M08A

Notes

Notes

For more National Semiconductor product information and proven design tools, visit the following Web sites at:

Products		Design Support	
Amplifiers	www.national.com/amplifiers	WEBENCH	www.national.com/webench
Audio	www.national.com/audio	Analog University	www.national.com/AU
Clock Conditioners	www.national.com/timing	App Notes	www.national.com/appnotes
Data Converters	www.national.com/adc	Distributors	www.national.com/contacts
Displays	www.national.com/displays	Green Compliance	www.national.com/quality/green
Ethernet	www.national.com/ethernet	Packaging	www.national.com/packaging
Interface	www.national.com/interface	Quality and Reliability	www.national.com/quality
LVDS	www.national.com/lvds	Reference Designs	www.national.com/refdesigns
Power Management	www.national.com/power	Feedback	www.national.com/feedback
Switching Regulators	www.national.com/switchers		
LDOs	www.national.com/lido		
LED Lighting	www.national.com/led		
PowerWise	www.national.com/powerwise		
Serial Digital Interface (SDI)	www.national.com/sdi		
Temperature Sensors	www.national.com/tempsensors		
Wireless (PLL/VCO)	www.national.com/wireless		

THE CONTENTS OF THIS DOCUMENT ARE PROVIDED IN CONNECTION WITH NATIONAL SEMICONDUCTOR CORPORATION ("NATIONAL") PRODUCTS. NATIONAL MAKES NO REPRESENTATIONS OR WARRANTIES WITH RESPECT TO THE ACCURACY OR COMPLETENESS OF THE CONTENTS OF THIS PUBLICATION AND RESERVES THE RIGHT TO MAKE CHANGES TO SPECIFICATIONS AND PRODUCT DESCRIPTIONS AT ANY TIME WITHOUT NOTICE. NO LICENSE, WHETHER EXPRESS, IMPLIED, ARISING BY ESTOPPEL OR OTHERWISE, TO ANY INTELLECTUAL PROPERTY RIGHTS IS GRANTED BY THIS DOCUMENT.

TESTING AND OTHER QUALITY CONTROLS ARE USED TO THE EXTENT NATIONAL DEEMS NECESSARY TO SUPPORT NATIONAL'S PRODUCT WARRANTY. EXCEPT WHERE MANDATED BY GOVERNMENT REQUIREMENTS, TESTING OF ALL PARAMETERS OF EACH PRODUCT IS NOT NECESSARILY PERFORMED. NATIONAL ASSUMES NO LIABILITY FOR APPLICATIONS ASSISTANCE OR BUYER PRODUCT DESIGN. BUYERS ARE RESPONSIBLE FOR THEIR PRODUCTS AND APPLICATIONS USING NATIONAL COMPONENTS. PRIOR TO USING OR DISTRIBUTING ANY PRODUCTS THAT INCLUDE NATIONAL COMPONENTS, BUYERS SHOULD PROVIDE ADEQUATE DESIGN, TESTING AND OPERATING SAFEGUARDS.

EXCEPT AS PROVIDED IN NATIONAL'S TERMS AND CONDITIONS OF SALE FOR SUCH PRODUCTS, NATIONAL ASSUMES NO LIABILITY WHATSOEVER, AND NATIONAL DISCLAIMS ANY EXPRESS OR IMPLIED WARRANTY RELATING TO THE SALE AND/OR USE OF NATIONAL PRODUCTS INCLUDING LIABILITY OR WARRANTIES RELATING TO FITNESS FOR A PARTICULAR PURPOSE, MERCHANTABILITY, OR INFRINGEMENT OF ANY PATENT, COPYRIGHT OR OTHER INTELLECTUAL PROPERTY RIGHT.

LIFE SUPPORT POLICY

NATIONAL'S PRODUCTS ARE NOT AUTHORIZED FOR USE AS CRITICAL COMPONENTS IN LIFE SUPPORT DEVICES OR SYSTEMS WITHOUT THE EXPRESS PRIOR WRITTEN APPROVAL OF THE CHIEF EXECUTIVE OFFICER AND GENERAL COUNSEL OF NATIONAL SEMICONDUCTOR CORPORATION. As used herein:

Life support devices or systems are devices which (a) are intended for surgical implant into the body, or (b) support or sustain life and whose failure to perform when properly used in accordance with instructions for use provided in the labeling can be reasonably expected to result in a significant injury to the user. A critical component is any component in a life support device or system whose failure to perform can be reasonably expected to cause the failure of the life support device or system or to affect its safety or effectiveness.

National Semiconductor and the National Semiconductor logo are registered trademarks of National Semiconductor Corporation. All other brand or product names may be trademarks or registered trademarks of their respective holders.

Copyright© 2008 National Semiconductor Corporation

For the most current product information visit us at www.national.com



**National Semiconductor
Americas Technical
Support Center**
Email:
new.feedback@nsc.com
Tel: 1-800-272-9959

**National Semiconductor Europe
Technical Support Center**
Email: europe.support@nsc.com
German Tel: +49 (0) 180 5010 771
English Tel: +44 (0) 870 850 4288

**National Semiconductor Asia
Pacific Technical Support Center**
Email: ap.support@nsc.com

**National Semiconductor Japan
Technical Support Center**
Email: jpn.feedback@nsc.com